

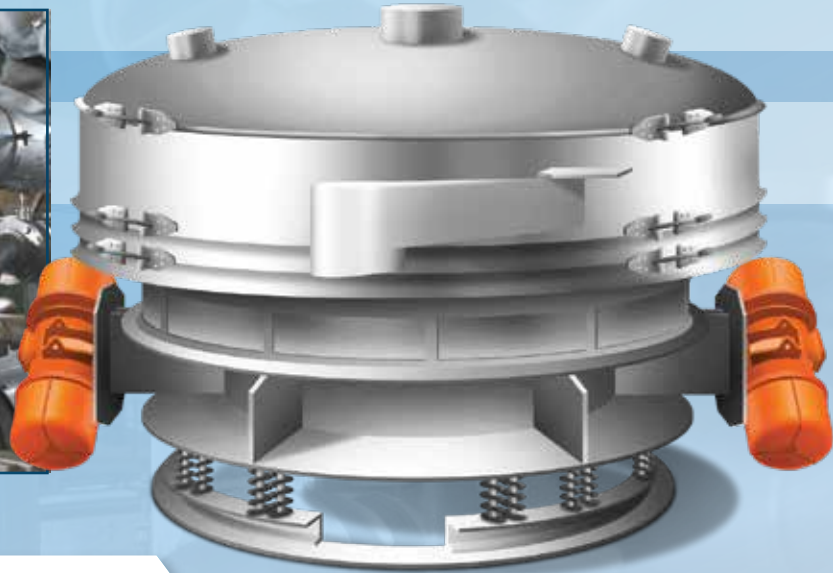

Low Profile Separator



# VIBRATORY MOTORS & DRIVES

# FOOD & BEVERAGE

Vibratory Motors for the Food & Beverage Industry

AIRMATIC  
284 Three Tun Rd. Malvern, PA 19355  
215.333.5600  
infocenter@airmatic.com  
airmatic.com

**Maximize uptime while minimizing cost** when purchasing an off-the-shelf replacement **Vibratory Motor** for your **Feeders, Separators, Sifters, Screeners, Classifiers, Shakers, Drums** and other **Vibratory Equipment** with Vibrator Motors from **AIRMATIC**. There is no longer a need to go back to the original equipment manufacturer for an expensive (both cost and lead time) replacement vibrator when you can buy an exact replacement Vibratory Drive directly from **AIRMATIC – North America's leading vibrator distributor**.



**Dewatering Screen**



**Spiral Elevator**

## OUR PRODUCTS

**AIRMATIC** stocks the nation's largest inventory of Foot-Mount Vibrator Motors used by most manufacturers of Feeders & Conveyors, Shakeouts, Screeners, Densifiers & De-aers, Classifiers, Separators, Sifters, and Settlers & Compactors, and we are a service center for most vibrator manufacturers.

**AIRMATIC** also stocks and services Vertical-Mount Vibrator Motors that are fully interchangeable with any Vibrator used on standard 48" and 60" Round Separator Machines made by the leading manufacturers of vibratory equipment.

## TECHNICAL SUPPORT

Need technical support or application assistance to solve a problem with your existing vibratory equipment or in selecting new equipment? Let our Consultants help. We have over 30 years' experience in vibratory equipment selection and troubleshooting, and because we don't represent any vibratory equipment manufacturers, we can provide expert and impartial recommendations.

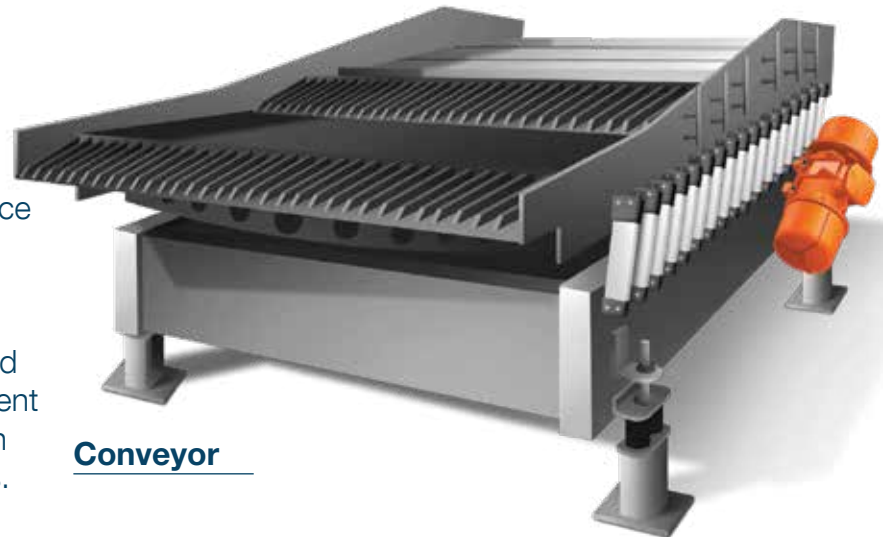

**Conveyor**

## VIBRATOR REPAIR

If a Vibrator Motor needs repair, contact **AIRMATIC at 800.332.9770**. Most electric motor repair shops are not trained to repair industrial Electric Vibrator Motors. We recommend that they be returned to our Malvern, PA Service Center. Attempting to repair Electric Vibrator Motors in-house or by a non-qualified repair shop – including bearing replacement – will void the manufacturer's warranty.

# FOOT MOUNTED VIBRATORY MOTORS



## 1800RPM

STAINLESS STEEL; THREE-PHASE POWER

Frame Size	Centrifugal Force LBF		Bolt Pattern	
	50 Hz	60 Hz	D	E
00	66	96	2.44-2.91*	4.17
01-A	171	167	2.44-2.91*	4.17
01-B	215	246	2.44-2.91*	4.17
10	769	471	3.54	4.92
20-A	906	904	4.13	5.51
20-B	1214	1302	4.13	5.51
30	1584	1672	4.72	6.69
35	2299	2160	4.72	6.69
40	3109	3188	5.51	7.48
50-A	3956	3865	5.51	7.48
50-B	4519	4473	5.51	7.48
60-A	5324	5377	6.10	8.86
60-B	6833	6835	6.10	8.86
70-A	8448	8237	6.10	10.04
70-B	9517	9350	6.10	10.04

**Also available:**

- Epoxy coated finish
- Single-Phase Power

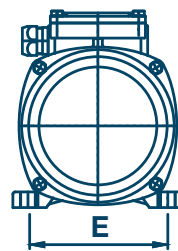
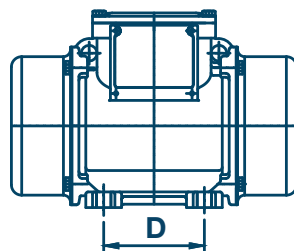

Request Spec Sheet  
for Complete  
Dimensional Data



## 1200RPM

STAINLESS STEEL; THREE-PHASE POWER

Frame Size	Centrifugal Force LBF		Bolt Pattern	
	50 Hz	60 Hz	D	E
10-A	77	108	3.54	4.92
10-B	207	299	3.54	4.92
20	403	581	4.13	5.51
30	706	744	4.72	6.69
35	1126	1624	4.72	6.69
40	1780	1991	5.51	4.48
50-A	2490	2531	5.51	7.48
50-B	3133	3163	5.51	7.48
60-A	3604	3408	6.10	8.86
60-B	4739	4624	6.10	8.86
70-A	5722	6043	6.10	10.04
70-B	6615	6873	6.10	10.04

**Also available:**

- Epoxy coated finish
- Single-Phase Power

Request Spec Sheet  
for Complete  
Dimensional Data

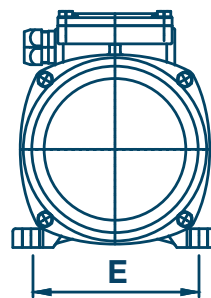
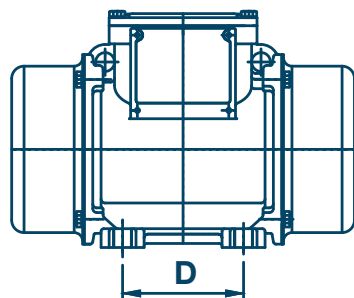

# FLANGE MOUNTED VIBRATORY MOTORS

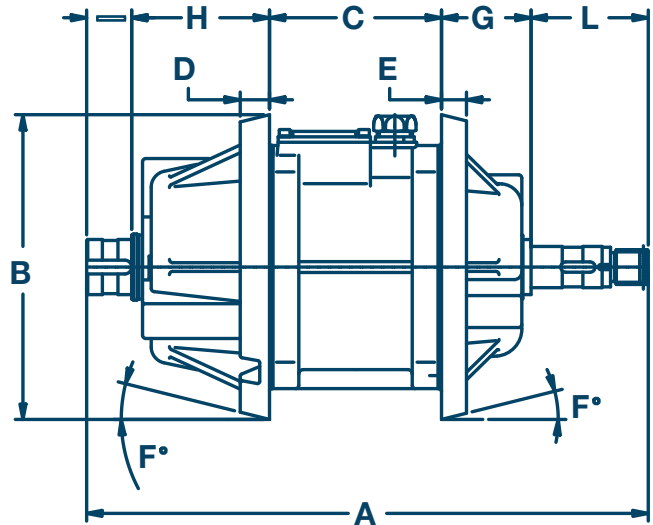

Request Spec Sheet  
for Complete  
Dimensional Data

## 1200RPM

Centrifugal Force LBF		Power Output HP		Bolt Pattern
50 Hz	60 Hz	50 Hz	60 Hz	B
5500	5500	2.3	2.5	11.06

## 1800RPM

Centrifugal Force LBF		Power Output HP		Bolt Pattern
50 Hz	60 Hz	50 Hz	60 Hz	B
5500	5500	2.0	2.5	11.06
11000	11000	4.0	3.7	13.46

## TECHNICAL FEATURES

**Motor Duty Cycle** - Continual service (S1) at maximum declared centrifugal force and electric power. Intermittent services are also possible depending on the type of vibrator and the operating conditions. For detailed information, contact our technical support office.

**Centrifugal Force** - Range extended up to 67000 lb, with centrifugal force adjustable from 0 to 100%.

**Mechanical Protection** - IP66 according to IEC 529, EN 60529.

**Mechanical Impact Protection** - IK 08 according to IEC 68, EN 50102.

**Insulation Class** - Class F (155°C), class H (180°C) on request.

**Tropicalization** - Standard on all Vibrators, with vacuum encapsulation up to size 35, with "drop by drop" trickle system for larger sizes.

**Ambient Temperature Ratings** - From -4°F to +104°F. Versions for higher or lower temperatures are available on request.

**Thermal Protection** - Standard PTC rated thermistor heat detectors 130°C (DIN 44081-44082) on size 70, on request for smaller sizes. On request, thermistors with different temperatures and anti-condensation heaters.

**Lubrication** - All Vibrators are lubricated at factory. Periodic re-lubrication recommended for size 35 and larger.

**Terminal Box** - Large fixed electrical connections. HD terminal cover (increased thickness) is built to contain internal explosions. Special shaped terminals enable power supply cable to be secured against loosening.

**Design** - Three-phase and single-phase asynchronous type. Designed for maximum starting torques and torque curves specific to vibratory motors. Insulated windings use vacuum encapsulating up to size 35; use the "drop by drop" trickle system with class H resin for larger sizes. The rotor is die cast aluminum.

**Housing Construction** - In stainless steel AISI 304, designed to to reduced buildup of dust and liquids.

**Bearing Flange** - Constructed in grey cast iron. Geometry of flange uniformly transmits load to the housing uniformly.

**Bearings** - Shielded ball bearings or roller bearings are used depending on frame size and polarity. Bearings used are engineered to meet the unique speed, radial and axial forces and load direction imposed by vibratory motors.

**Motor Shaft** - Treated steel Alloy (isothermic hardening) resistant to stress.

**Eccentric Weights** - Allow continual adjustment of the centrifugal force. This adjustment can be read on a graduated scale, which shows the centrifugal force as a percentage of the maximum centrifugal force. A patented system (patent N° MO98A000194), called ARS, prevents adjustment errors.

**Weight Covers** - In Heavy-Duty Cast Aluminum with machined mechanical seal to combine the advantages of engineered sealing with the durability of a solid one-piece cover.

## VIBRATORY REPAIR

Most of the Vibratory Equipment OEMs and most electric motor repair shops are not trained to repair Rotary Electric Vibrator Motors which, unlike balanced induction motors, are specifically designed to generate vibration and built to withstand the loads imposed. Attempting to repair Electric Vibrator Motors in-house or by a non-qualified repair shop will lead to motors that are not performing to specifications or failing prematurely, and will, in most cases, void the motor manufacturer's warranty. Qualified Service Centers, like **AIRMATIC** use only genuine replacement parts, including bearings and specially formulated grease.

### Certifications



## Vibratory Motor Maintenance Best Practices

**To prolong the life of your Motors, we recommend that all vibrators be inspected every three months After Lockout/Tagout and other safety considerations, we suggest the following:**

1. Perform visual inspection of Motor's housing, closely looking for cracks in mount feet, mount flanges, or the housing. If damage is found remove the Motor from service and return it to AIRMATIC or another authorized repair facility for a detailed repair/inspection, report of findings and a quotation for repair.
2. Perform visual inspection of the Electric Vibrator's mounting plate on the vibrating equipment. If damaged areas are discovered, remove equipment from service until an in-depth equipment inspection/repair has been performed by qualified technicians.
3. Inspect the power supply cord and thermistor circuit cord. Replace cords if there are signs of damage and wear.
4. Remove the Vibrator's wiring box cover and inspect for foreign matter or liquid. Vacuum-out foreign matter. If wet, remove motor from service and have ground insulation tested by a licensed technician. Before replacing wiring box cover, make sure electrical connections are tight (do not over-tighten) and inspect cover's O-ring and rubber compression block. If O-ring or rubber compression block is damaged or has lost compression-set, replace.
5. Visually inspect the Vibrator's weight covers. If damaged, remove and replace. If not damaged, remove weight covers and inspect for foreign matter. Vacuum if necessary. Replace O-rings if damaged or have lost compression-set. It is not unusual to find extra grease inside of the weight cover, simply remove the excess grease. When reinstalling weight cover, be sure the cover bolts are torqued to manufacturer's specifications.
6. Extreme operating demands imposed on Vibratory Motors require strict adherence to manufacturer's specifications on brand and type of grease. Grease specifications and lubrication schedules vary based on Vibrator's speed, duty cycle, and environment (consult the manufacturer's O/O Manual for specifics). Generally, Vibratory Motors must be relubricated every 2000-hours of operation. NOTE: Never mix grease types or brands.
7. Check torque on all mounting bolts before initial start-up and again after first 40 hours of motor operation. Thereafter, test/verify mount bolt torque every 1000-hours of operation or on a yearly basis whichever occurs first. If one or more mount bolts has been removed or is missing, dispose of all bolts, nuts and washers, and replace with mounting hardware meeting manufacture's exact specification. Always use new "sets" of bolts, nuts and compression washers. Do not use split lock washers, only compression washers must be used. Use a recently calibrated torque wrench to tighten mounting hardware to manufacturer's torque specification.
8. If a Vibrator Motor has been removed for service, before remounting make sure the mounting surface is flat ( $\leq 0.01$ " across bolt holes), and clean (free of all dirt, oil, rust, and paint). Failure to mount a Vibratory Motor to a flat surface, or failure to remove foreign material between the Vibrator's mount feet and the mounting plate surface will result in mount bolt failure, and possible damage to the Vibrator and/or the Vibratory Equipment.



**AIRMATIC** founded in 1944, is a woman-owned Industrial Distributor, with installation and maintenance capabilities, offering equipment, machinery, and shop supplies to the Industrial, Construction, Utility, Government, and Commercial Markets. Our products and services are sold through three business units:

The **MATERIALS MANAGEMENT GROUP** provides products and services to industries that convey, store, transport, and process powders and bulk solids from aggregates, cement, and chemicals to foods, grains, metals, power generation, and waste water treatment applications;

The **SERVICE GROUP** provides fabrication, installation, and maintenance services to improve bulk materials handling efficiency; mechanical clean-out services for silos and hoppers to eliminate material flow problems; and shop repair/rebuilding and modifications services of products sold by the Company.

The **TOOL GROUP** provides power tools, personal protective equipment, materials-handling equipment, shop equipment and MRO supplies used for production, fabrication, assembly, metal removal, maintenance, and storage in manufacturing, construction, utility, and commercial applications. Our Customers tell us that by choosing **AIRMATIC** to solve their problems, they gain increased productivity, decreased costs, and a safer, cleaner work environment.

## **AIRMATIC**

284 Three Tun Rd. Malvern, PA 19355

215.333.5600

infocenter@airmatic.com

airmatic.com